



OKAPOVÝ SYSTÉM PŮLKRUHOVÝ



CENÍK
2023

DOPORUČENÉ SPOTŘEBITELSKÉ CENY



POWERFUL PARTNER FOR YOUR ROOF



Hliníkový materiál | 4



Žlab | 6



Žlabová dilatace | 9



Žlab příslušenství | 13



Žlabový hák | 15



Roh | 18



Čelo žlabové | 20



Kotlík žlabový | 21



Koleno | 32



Svodová roura | 35



Svodová roura příslušenství | 40



Objímka | 42

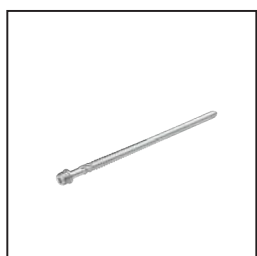

Objímka příslušenství | 43



Dešťová klapka | 45



Svod ochranný | 48

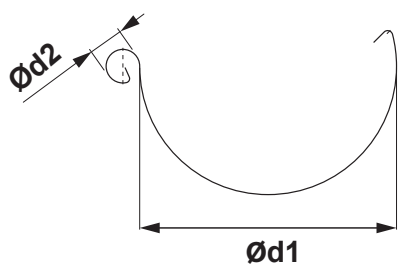

ROZMĚRY STŘEŠNÍCH ŽLABŮ

(rozměry a rozměrové tolerance podle EN 612)

Rozvinutá šířka (mm)	200	250	280	333	400
Ød1	80	105	127	153	192
Ød2	16	18	18	20	22

VNITŘNÍ FALZ

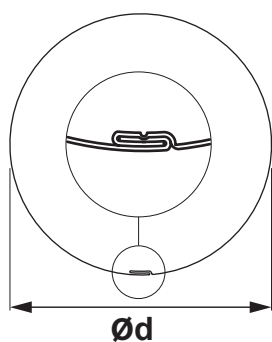

ROZMĚRY STŘEŠNÍCH SVODŮ

(rozměry a rozměrové tolerance podle EN 612)

Rozměry	60	80	100	120	150
Jmenovitá velikost Ød (mm)	60	80	100	120	150

ROZMĚRY STŘEŠNÍCH HÁKŮ

(rozměry a rozměrové tolerance podle EN 612)

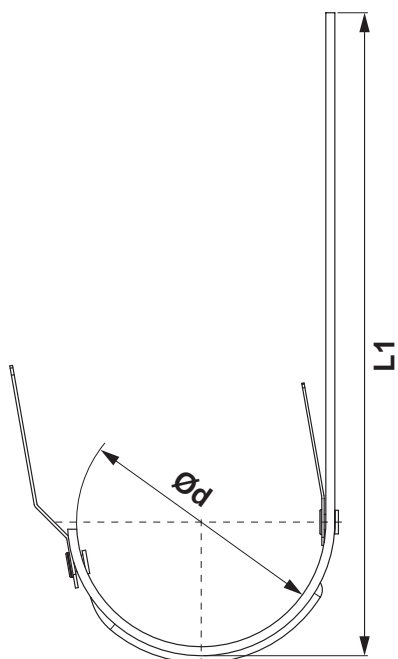

Rozměry (mm)	L1	Ød
200	290	80
250	310	105
280	345	127
333 – 550	385	153
333 – 610	445	153
400	400	192

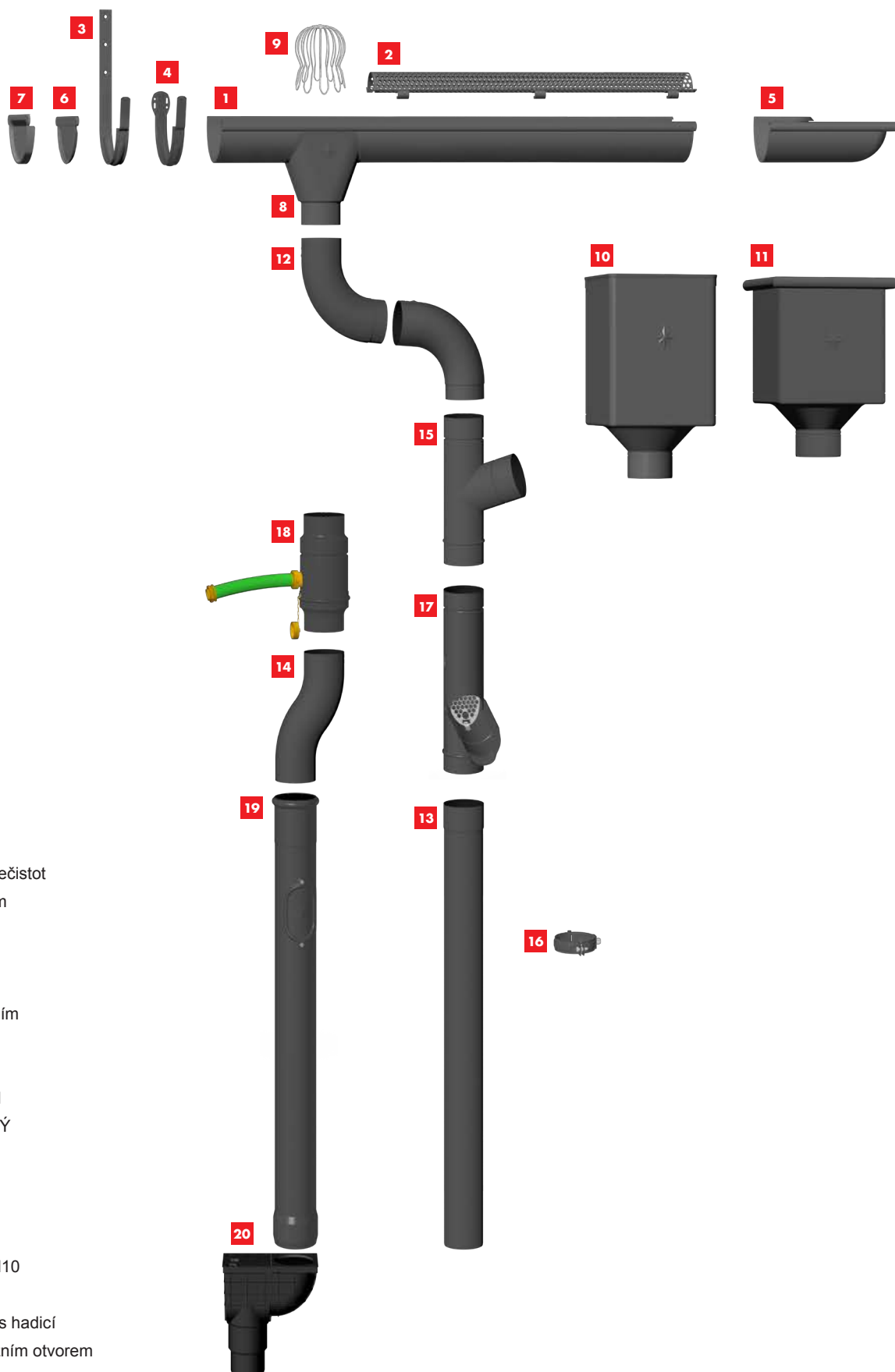

- 1** Žlab půlkruhový
- 2** Mřížka zachytávače nečistot
- 3** Žlabový hák s prolisem
- 4** Hák žlabový čelní
- 5** Roh vnější
- 6** Čelo žlabové
- 7** Čelo žlabové s těsněním
- 8** Kotlík žlabový
- 9** Lapač listí
- 10** Sběrný kotlík DESIGN
- 11** Sběrný kotlík KUBICKÝ
- 12** Koleno
- 13** Svodová roura
- 14** Koleno soklové
- 15** Svodová odbočka
- 16** Objímka se závitem M10
- 17** Dešťová klapka
- 18** Sběrač dešťové vody s hadicí
- 19** Svod ochranný s revizním otvorem
- 20** Kanalizační vpust' přímá



ALUMINIUM POLYESTER + NATUR

NOVELIS

Je americká průmyslová hliníková společnost se sídlem v Atlantě ve státě Georgia ve Spojených státech. Je dceřinou společností indické společnosti pro výrobu hliníku a mědi Hindalco Industries. Novelis je předním výrobcem válcovaného hliníku a globálním lídrem v recyklaci nápojových plechovek. Společnost poskytuje služby zákazníkům v odvětvích včetně plechovek na nápoje, automobilového průmyslu, spotřební elektroniky, stavebnictví, fólií a obalů.

ADITYA BIRLA



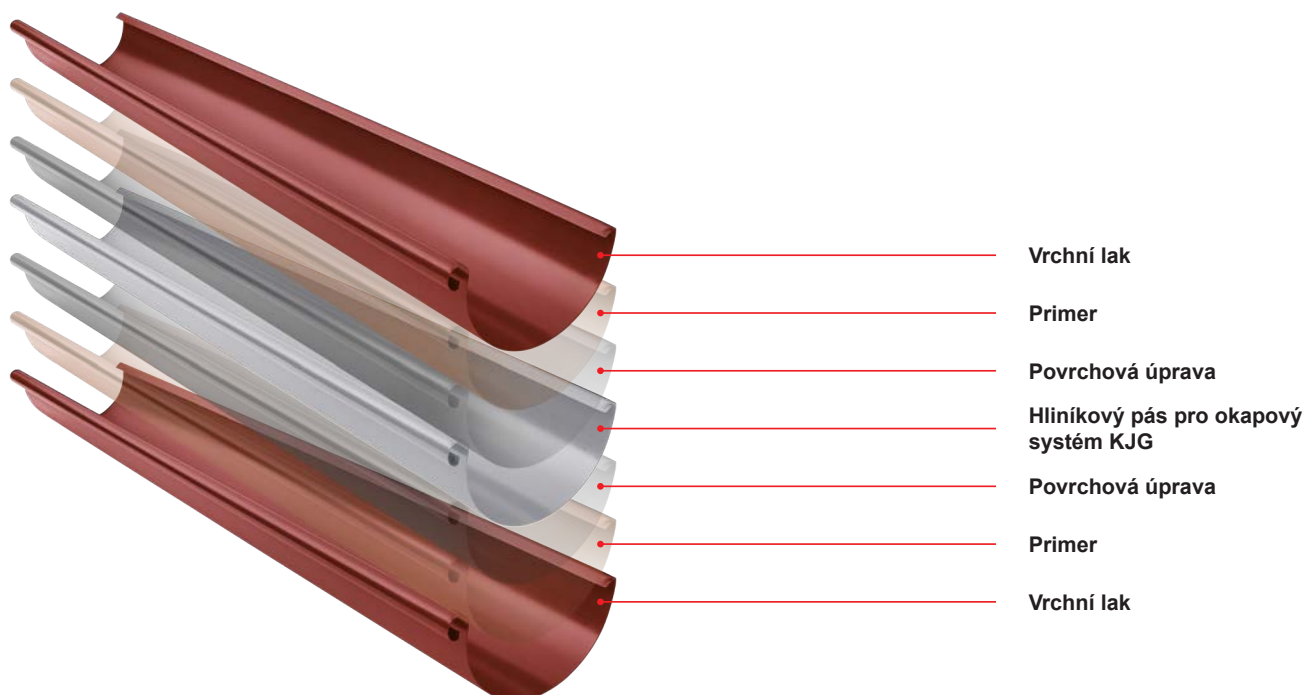

SPEIRA

Speira je globální společnost pro válcování a recyklaci hliníku. Skládá se ze sedmi výrobních závodů a jednoho výzkumného a vývojového centra. Nacházející se v Německu a Norsku včetně našeho společného podniku Alunorf, největší válcovny hliníku na světě, Grevenbroich, největší dokončovací válcovny hliníku na světě, jakož i několika mezinárodních prodejních kanceláří. Speira zaměstnává kolem 5 000 lidí hlavně v Německu a Norsku.



ŽLAB PŮLKRUHOVÝ [s=0,70]

W-WZ

Jmenovitá velikost	200	250	250	280	280
Délka v m	3,0	4,0	6,0	4,0	6,0
Cena v CZK/m	S DPH	S DPH	S DPH	S DPH	S DPH
AN 1 Antracit RAL 7016	239,00	195,00	195,00	249,00	249,00
	051066 *	051073	051080	051097	051103
TM 2 Testa di Moro RAL 8028	239,00	195,00	195,00	249,00	249,00
	051707 *	051714	051721	051738	051745
SS 3 Světle šedá RAL 7005		195,00	195,00	249,00	249,00
		051639	051646	051653	051660
ZH 4 Zeleno hnědá RAL 7013		195,00	195,00	249,00	249,00
		051790	051806	051813	051820
BH 5 Bílo hliníková RAL 9006		195,00	195,00	249,00	249,00
		051233	051240 *	051257	051264
BHT 6 Bílo hliníková tmavá RAL 9007		195,00	195,00	249,00	249,00
		101891 *	101907 *	101914 *	101921 *
MH 7 Měděno hnědá RAL 8004		195,00	195,00	249,00	249,00
		051394	051400	051417	051424
IC 8 Intenzivní černá RAL 9005		195,00	195,00	249,00	249,00
		051318	051325 *	051332	051349 *
OC 9 Ocelově červená RAL 3009		195,00	195,00	249,00	249,00
		051554	051561	051578	051585
B 10 Bílá RAL 9010		195,00	195,00	249,00	249,00
		051158	051165	051172	051189
MZ 11 Mechově zelená RAL 6005		195,00	195,00	249,00	249,00
		051479	051486	051493	051509
ZS 12 Zinkově šedá RAL extra		195,00	195,00	249,00	249,00
		051875	051882 *	051899 *	051905 *
PZ 13 Patina zelená RAL extra					
PM 14 Patina měděná RAL extra					
Hliník 15 Natur		176,00	176,00	203,00	203,00
		049957	049964	049971	049988
Balení v m 	15	20	30	20	30
Balení v m 	1 200	960	1 440	840	1 260

* Výroba na objednávku



ŽLAB PŮLKRUHOVÝ [s=0,70]

W-WZ



Jmenovitá velikost	333	333	400
Délka v m	4,0	6,0	6,0
Cena v CZK/m	S DPH	S DPH	S DPH
AN 1 Antracit RAL 7016	251,00	251,00	369,00
	051110	051127	051134
TM 2 Testa di Moro RAL 8028	251,00	251,00	369,00
	051752	051769	051776 *
SS 3 Světle šedá RAL 7005	251,00	251,00	369,00
	051677	051684	051691
ZH 4 Zeleno hnědá RAL 7013	251,00	251,00	369,00
	051837	051844	051851
BH 5 Bílo hliníková RAL 9006	251,00	251,00	369,00
	051271	051288	051295
BHT 6 Bílo hliníková tmavá RAL 9007	251,00	251,00	369,00
	101938	101945	070104 *
MH 7 Měděno hnědá RAL 8004	251,00	251,00	369,00
	051431	051448	051455 *
IC 8 Intenzivní černá RAL 9005	251,00	251,00	369,00
	051356	051363	051370 *
OC 9 Ocelově červená RAL 3009	251,00	251,00	369,00
	051592	051608	051615 *
B 10 Bílá RAL 9010	251,00	251,00	369,00
	051196	051202	051219 *
MZ 11 Mechově zelená RAL 6005	251,00	251,00	369,00
	051516	051523	051530
ZS 12 Zinkově šedá RAL extra	251,00	251,00	369,00
	051912	051929	051936 *
PZ 13 Patina zelená RAL extra	369,00	369,00	
	112781 *	112798	
PM 14 Patina měděná RAL extra	369,00	369,00	
	112767 *	112774	
Hliník 15 Natur	224,00	224,00	305,00
	049995	050007	050014
Balení v m 	20	30	30
Balení v m 	660	990	810

* Výroba na objednávku



ŽLAB NÁSTŘEŠNÍ [s=0,70]

W-WZS



Jmenovitá velikost	650	700	700
Délka v m	6,0	4,0	6,0
Cena v CZK/m	S DPH	S DPH	S DPH
AN 1 Antracit RAL 7016		847,00	847,00
		049193	049209
TM 2 Testa di Moro RAL 8028	654,00		
	049308 *		
SS 3 Světle šedá RAL 7005		847,00	847,00
		049285 *	049292
ZH 4 Zeleno hnědá RAL 7013		847,00	847,00
		049315	049322
BH 5 Bílo hliníková RAL 9006	654,00		
	049223 *		
BHT 6 Bílo hliníková tmavá RAL 9007	654,00		
	101990 *		
MH 7 Měděno hnědá RAL 8004	654,00		
	049247 *		
IC 8 Intenzivní černá RAL 9005	654,00		
	049230 *		
OC 9 Ocelově červená RAL 3009	654,00		
	049278 *		
B 10 Bílá RAL 9010	654,00		
	049216 *		
MZ 11 Mechově zelená RAL 6005		847,00	847,00
		049254	049261
ZS 12 Zinkové šedá RAL extra	654,00		
	049339 *		
PZ 13 Patina zelená RAL extra			
PM 14 Patina měděná RAL extra			
Hliník 15 Natur	569,00		
	049186 *		
Balení v m 	6	4	6
Balení v m 	300	200	300

* Výroba na objednávku



ŽLABOVÁ DILATACE

W-WZDI

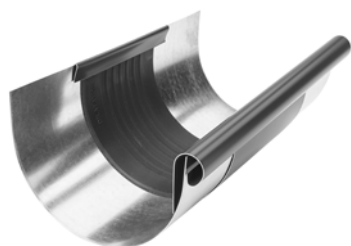

Jmenovitá velikost	250/260	285/260	333/260	400/260
Cena v CZK/ks	S DPH	S DPH	S DPH	S DPH
AN 1 Antracit RAL 7016	695,00 028341 *	728,00 028358 *	728,00 028365	915,00 028372
TM 2 Testa di Moro RAL 8028	695,00 028662 *	728,00 028679 *	728,00 028686	915,00 028693 *
SS 3 Světle šedá RAL 7005	695,00 028624 *	728,00 028631 *	728,00 028648 *	915,00 028655 *
ZH 4 Zeleno hnědá RAL 7013	695,00 028709 *	728,00 028716 *	728,00 028723 *	915,00 028730 *
BH 5 Bílo hliníková RAL 9006	695,00 028426 *	728,00 028433 *	728,00 028440	915,00 028457
BHT 6 Bílo hliníková tmavá RAL 9007	695,00 101440 *	728,00 101457 *	728,00 101464 *	915,00 070135 *
MH 7 Měděno hnědá RAL 8004	695,00 028501 *	728,00 028518 *	728,00 028525 *	915,00 028532 *
IC 8 Intenzivní černá RAL 9005	695,00 028464 *	728,00 028471 *	728,00 028488 *	915,00 028495 *
OC 9 Ocelově červená RAL 3009	695,00 028587 *	728,00 028594 *	728,00 028600 *	915,00 028617 *
B 10 Bílá RAL 9010	695,00 028389 *	728,00 028396 *	728,00 028402 *	915,00 028419 *
MZ 11 Mechově zelená RAL 6005	695,00 028549 *	728,00 028556 *	728,00 028563 *	915,00 028570 *
ZS 12 Zinkově šedá RAL extra	695,00 028747 *	728,00 028754 *	728,00 028761 *	915,00 028778 *
PZ 13 Patina zelená RAL extra			1 101,00 112590 *	
PM 14 Patina měděná RAL extra			1 101,00 112583 *	
Hliník 15 Natur	769,00 028303 *	800,00 028310 *	864,00 028327 *	1 074,00 028334 *
Balení v ks 	3	3	5	5
Balení v ks 	360	360	200	200

* Výroba na objednávku



DILATACE NÁSTŘEŠNÍHO ŽLABU

W-WZSDI

Jmenovitá velikost	670/260
Cena v CZK/ks	S DPH
AN 1 Antracit RAL 7016	2 202,00 029157 *
TM 2 Testa di Moro RAL 8028	2 202,00 029232 *
SS 3 Světle šedá RAL 7005	2 202,00 029225 *
ZH 4 Zeleno hnědá RAL 7013	2 202,00 029249 *
BH 5 Bílo hliníková RAL 9006	2 202,00 029171 *
BHT 6 Bílo hliníková tmavá RAL 9007	2 202,00 101471 *
MH 7 Měděno hnědá RAL 8004	2 202,00 029195 *
IC 8 Intenzivní černá RAL 9005	2 202,00 029188 *
OC 9 Ocelově červená RAL 3009	2 202,00 029218 *
B 10 Bílá RAL 9010	2 202,00 029164 *
MZ 11 Mechově zelená RAL 6005	2 202,00 029201 *
ZS 12 Zinkově šedá RAL extra	2 202,00 029256 *
PZ 13 Patina zelená RAL extra	
PM 14 Patina měděná RAL extra	
Hliník 15 Natur	1 982,00 029140 *
Balení v ks 	1
Balení v ks 	40



* Výroba na objednávku





DILATAČNÍ PÁS

W-WZDIP

Jmenovitá velikost	Délka v m	EAN číslo výrobku	Balení v m		Cena s DPH [CZK/m]
					
260	3,0	028181	3	120	1 355,00

POUŽITÍ DILATAČNÍHO ŽLABU A PÁSOVÉ DILATACE

DILATAČNÍ ŽLAB

Příklad montáže: Podokapový žlab o rozvinuté šířce do 500 mm. Dilatační žlab musí být namontován v rozestupu 15 m. Pro vnější roh a začátek žlabu platí polovina standardní hodnoty: maximálně 7,5 m. Pro vnitřní roh platí čtvrtina standardní hodnoty: maximálně 3,75 m. Pro ostatní materiály a rozměry: viz tabulka níže. Rohy se vždy počítají jako pevné body.

PÁSOVÁ DILATACE

Vnitřní instalace: na žlaby uchycené bez lepení na podklad, střechy s nestandardním profilem a oplechování zdiva.

STŘEŠNÍ PŮLKRUHOVÉ DILATAČNÍ ŽLABY

Rozvinutá šířka žlabu	Hliník	Pozink, Titan-zinek, Měď, Nerez
< 500	12	15
> 500	8	10

STŘEŠNÍ PÁSOVÁ DILATACE

Rozvinutá šířka žlabu	Hliník	Pozink, Titan-zinek, Měď, Nerez
< 500	8	10
> 500	6	8

Pre vonkajší roh alebo začiatok žlabu platí polovica štandardnej hodnoty. Pre vnútorný roh platí jedna štvrtina štandardnej hodnoty.

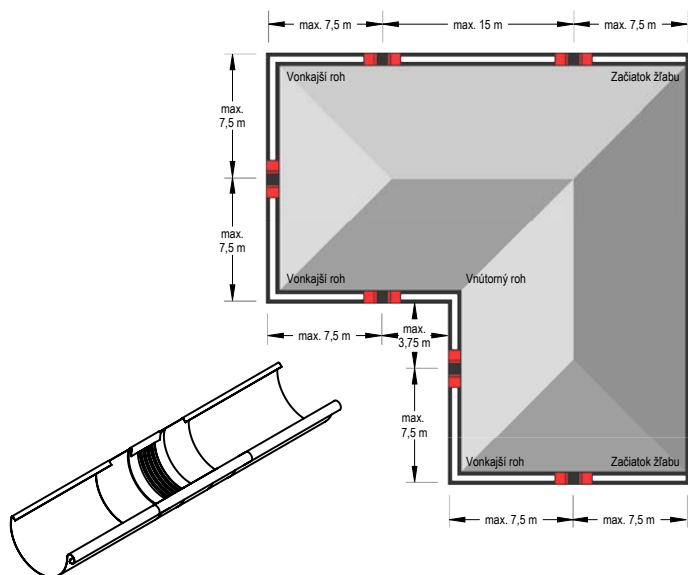

Poznámka k montáži dilatačního žlabu.

Při montáži pomocí pájení nejprve střední gumový díl překryjte mokrým hadříkem (aby nedošlo k prostupu tepla do středního gumového dílu). Musí se dodržet minimální vzdálenost 6 cm od střední gumové části. V každém případě je třeba se vyhnout kontaktu gumy s otevřeným plamenem.

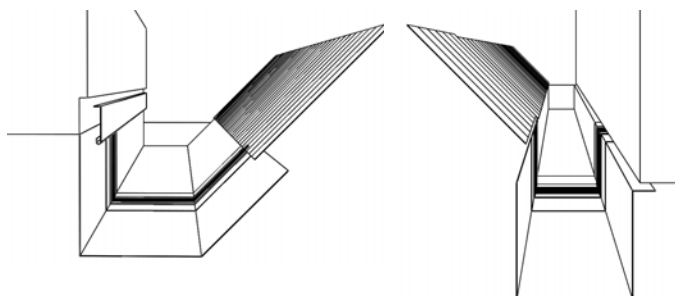



Poznámka k montáži dilatačního pásu.

Při ohýbání a montáži dilatačních prvků se ujistěte, že:

- ohýbací čelisti mají rádius minimálně 2 mm.
- pro tloušťku plechu od 1 mm musí být dodržen poloměr ohybu minimálně 5 mm.
- ohýbací čelisti musí být při ohýbání nastaveny na tloušťku střední gumové části 3 až 4 mm, aby se zabránilo stříhacího efektu - poškození gumy.
- Gumová střední část nesmí být během ohýbání stlačena nebo poškozená. Proto by měl být použit hliníkový plechový pás 2 až 5 mm (hrubý) ohnutý tak, aby mohl být připevněn jako ochrana na ohýbací čelisti. Tím se dosáhne větší poloměr ohybu a zabrání se porušení gumové střední části.

MŘÍŽKA ZACHYTÁVAČE NEČISTOT

W-WZNL M

Jmenovitá velikost		333
Délka v m		2,0
Cena v CZK/ks		S DPH
AN 1 Antracit RAL 7016		898,00 064950
TM 2 Testa di Moro RAL 8028		898,00 064981 *
SS 3 Světle šedá RAL 7005		898,00 064974
ZH 4 Zeleno hnědá RAL 7013		898,00 118127 *
BH 5 Bílo hliníková RAL 9006		898,00 118080 *
BHT 6 Bílo hliníková tmavá RAL 9007		898,00 118097 *
MH 7 Měděno hnědá RAL 8004		898,00 118103 *
IC 8 Intenzivní černá RAL 9005		898,00 118059
OC 9 Ocelově červená RAL 3009		898,00 118066 *
B 10 Bílá RAL 9010		898,00 118134 *
MZ 11 Mechově zelená RAL 6005		898,00 118110 *
ZS 12 Zinkově šedá RAL extra		898,00 118073 *
PZ 13 Patina zelená RAL extra		
PM 14 Patina měděná RAL extra		
Hliník 15 Natur		864,00 064905
Balení v ks 		15
Balení v ks 		120

* Výroba na objednávku

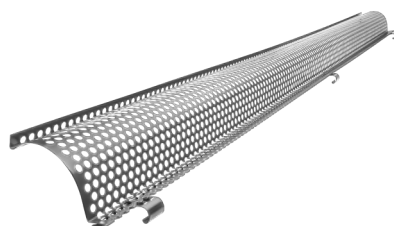



ALUMINIUM

POLYESTER + NATUR

PVC MŘÍŽKA ZACHYTÁVAČE LISTÍ

SD-ZNL MRIEZKA

Jmenovitá velikost	Délka v m	EAN číslo výrobku	Balení v ks		Cena s DPH [CZK/ks]
PS 171	1,0	008473	30	450	152,00
TM 171	1,0	008466	30	450	152,00

PVC MŘÍŽKA ZACHYTÁVAČE LISTÍ

SD-ZNL N

Jmenovitá velikost	Délka v m	EAN číslo výrobku	Balení v ks		Cena s DPH [CZK/ks]
250	3,0	008480	10	400	810,00
280-333	3,0	008497	10	400	813,00

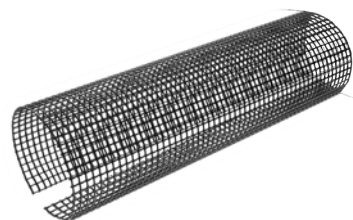
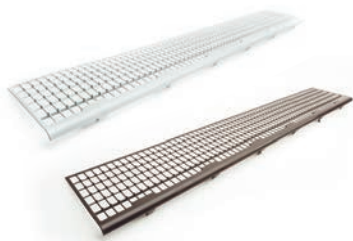

STŘEŠNÍ ŽLABOVÝ HÁK S PROLISEM

W-WHP



Jmenovitá velikost	250/430	280/480	333/550	333/650	400/650
Materiál	23/7	28/7	28/7	28/7	30/7
Cena v CZK/ks	S DPH	S DPH	S DPH	S DPH	S DPH
AN 1 Antracit RAL 7016	147,00	169,00	185,00	215,00	227,00
	077615	077622	077639	077646	077653
TM 2 Testa di Moro RAL 8028	147,00	169,00	185,00	215,00	227,00
	078018	078025	078032	078049	078056
SS 3 Světle šedá RAL 7005	147,00	169,00	185,00	215,00	227,00
	077967	077974	077981	077998	078001
ZH 4 Zeleno hnědá RAL 7013	147,00	169,00	185,00	215,00	227,00
	078063	078070	078117	078087	078094
BH 5 Bílo hliníková RAL 9006	147,00	169,00	185,00	215,00	227,00
	077714	077738	077721	077745 *	077752
BHT 6 Bílo hliníková tmavá RAL 9007	147,00	169,00	185,00	215,00	227,00
	101488 *	101495 *	101501	101518 *	080264 *
MH 7 Méděno hnědá RAL 8004	147,00	169,00	185,00	215,00	227,00
	077813	077820	077837	077844 *	077851
IC 8 Intenzivní černá RAL 9005	147,00	169,00	185,00	215,00	227,00
	077769	077776	077783	077790 *	077806
OC 9 Ocelově červená RAL 3009	147,00	169,00	185,00	215,00	227,00
	077912	077929	077936	077943 *	077950
B 10 Bílá RAL 9010	147,00	169,00	185,00	215,00	227,00
	077660	077677	077684	077691 *	077707
MZ 11 Mechově zelená RAL 6005	147,00	169,00	185,00	215,00	227,00
	077868	077899	077875	077882	077905
ZS 12 Zinkově šedá RAL extra	147,00	169,00	185,00	215,00	227,00
	078124	078100	078131	078148 *	078155 *
PZ 13 Patina zelená RAL extra			305,00		
			112613		
PM 14 Patina méděná RAL extra			305,00		
			112606		
Hliník 15 Natur	119,00	136,00	154,00	171,00	193,00
	011930	011947	077585	077592	077608
Balení v ks 	25	25	25	15	20
Balení v ks 	1 000	1 000	1 000	600	800

* Výroba na objednávku



HÁK ŽLABOVÝ ČELNÍ

W-WHPK



Jmenovitá velikost	250	280	333
Materiál	28/7	28/7	28/7
Cena v CZK/ks	S DPH	S DPH	S DPH
AN 1 Antracit RAL 7016	161,00 011596	163,00 011602	164,00 011619
TM 2 Testa di Moro RAL 8028	161,00 011831	163,00 011848	164,00 011855
SS 3 Světle šedá RAL 7005	161,00 011800	163,00 011817 *	164,00 011824
ZH 4 Zeleno hnědá RAL 7013	161,00 011862	163,00 011879	164,00 011886
BH 5 Bílo hliníková RAL 9006	161,00 011657	163,00 011664	164,00 011671
BHT 6 Bílo hliníková tmavá RAL 9007	161,00 101402 *	163,00 101396 *	164,00 101389 *
MH 7 Měděno hnědá RAL 8004	161,00 011718	163,00 011725 *	164,00 011732
IC 8 Intenzivní černá RAL 9005	161,00 011688	163,00 011695 *	164,00 011701
OC 9 Ocelově červená RAL 3009	161,00 011770 *	163,00 011787 *	164,00 011794
B 10 Bílá RAL 9010	161,00 011626	163,00 011633	164,00 011640
MZ 11 Mechově zelená RAL 6005	161,00 011749	163,00 011756	164,00 011763
ZS 12 Zinkově šedá RAL extra	161,00 011893 *	163,00 011909 *	164,00 011916 *
PZ 13 Patina zelená RAL extra			
PM 14 Patina měděná RAL extra			
Hliník 15 Natur	129,00 011565	130,00 011572	132,00 011589
Balení v ks 	25	25	25
Balení v ks 	1 000	1 000	1 000

* Výroba na objednávku



HÁK ŽLABOVÝ NÁSTRĚŠNÍ

W-WHSG

Jmenovitá velikost	4
Materiál	28/7
Cena v CZK/ks	S DPH
AN 1 Antracit RAL 7016	346,00 034113
TM 2 Testa di Moro RAL 8028	346,00 034199 *
SS 3 Světle šedá RAL 7005	346,00 034182
ZH 4 Zeleno hnědá RAL 7013	346,00 034205
BH 5 Bílo hliníková RAL 9006	346,00 034137
BHT 6 Bílo hliníková tmavá RAL 9007	346,00 101525 *
MH 7 Měděno hnědá RAL 8004	346,00 034151
IC 8 Intenzivní černá RAL 9005	346,00 034144 *
OC 9 Ocelově červená RAL 3009	346,00 034175 *
B 10 Bílá RAL 9010	346,00 034120 *
MZ 11 Mechově zelená RAL 6005	346,00 034168
ZS 12 Zinkově šedá RAL extra	346,00 034212 *
PZ 13 Patina zelená RAL extra	
PM 14 Patina měděná RAL extra	
Hliník 15 Natur	315,00 034229 *
Balení v ks 	15
Balení v ks 	600

* Výroba na objednávku



ROH VNĚJŠÍ

W-WRA

Jmenovitá velikost	200	250	280	333	400
Cena v CZK/ks	S DPH	S DPH	S DPH	S DPH	S DPH
AN 1 Antracit RAL 7016		501,00	525,00	549,00	983,00
		082220	082237	082244	082251
TM 2 Testa di Moro RAL 8028		501,00	525,00	549,00	983,00
		082541	082558	082565	082572 *
SS 3 Světle šedá RAL 7005		501,00	525,00	549,00	983,00
		082503	082510	082527	082534
ZH 4 Zeleno hnědá RAL 7013		501,00	525,00	549,00	983,00
		082589	082596	082602	082619 *
BH 5 Bílo hliníková RAL 9006		501,00	525,00	549,00	983,00
		082305	082312 *	082329	082336 *
BHT 6 Bílo hliníková tmavá RAL 9007		501,00	525,00	549,00	983,00
		101839 *	101846 *	101853	080295 *
MH 7 Měděno hnědá RAL 8004		501,00	525,00	549,00	983,00
		082381	082398	082404	082411 *
IC 8 Intenzivní černá RAL 9005		501,00	525,00	549,00	983,00
		082343	082350	082367	082374 *
OC 9 Ocelově červená RAL 3009		501,00	525,00	549,00	983,00
		082466	082473	082480	082497 *
B 10 Bílá RAL 9010		501,00	525,00	549,00	983,00
		082268	082275	082282	082299 *
MZ 11 Mechově zelená RAL 6005		501,00	525,00	549,00	983,00
		082428	082435	082442	082459 *
ZS 12 Zinkově šedá RAL extra		501,00	525,00	549,00	983,00
		082626	082633	082640	082657 *
PZ 13 Patina zelená RAL extra				600,00	
				112736	
PM 14 Patina měděná RAL extra				600,00	
				112729	
Hliník 15 Natur	451,00	451,00	473,00	495,00	884,00
	000514 *	000521	000538	000545	000552 *
Balení v ks 	5	5	5	5	5
Balení v ks 	150	150	150	150	150

* Výroba na objednávku



ROH VNITŘNÍ

W-WRI

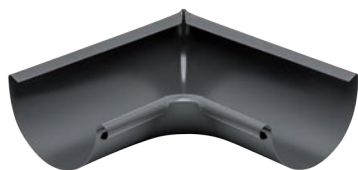

Jmenovitá velikost	200	250	280	333	400
Cena v CZK/ks	S DPH	S DPH	S DPH	S DPH	S DPH
AN 1 Antracit RAL 7016		501,00	525,00	549,00	983,00
		081780	081797	081803	081810
TM 2 Testa di Moro RAL 8028		501,00	525,00	549,00	983,00
		082107	082114	082121	082138
SS 3 Světle šedá RAL 7005		501,00	525,00	549,00	983,00
		082060	082077	082084	082091 *
ZH 4 Zeleno hnědá RAL 7013		501,00	525,00	549,00	983,00
		082145	082152	082169	082176 *
BH 5 Bílo hliníková RAL 9006		501,00	525,00	549,00	983,00
		081865 *	081872 *	081889	081896 *
BHT 6 Bílo hliníková tmavá RAL 9007		501,00	525,00	549,00	983,00
		101860 *	101877 *	101884	069221 *
MH 7 Měděno hnědá RAL 8004		501,00	525,00	549,00	983,00
		081940	081957	081964	081971 *
IC 8 Intenzivní černá RAL 9005		501,00	525,00	549,00	983,00
		081902	081919	081926	081933 *
OC 9 Ocelově červená RAL 3009		501,00	525,00	549,00	983,00
		082022	082039	082046	082053 *
B 10 Bílá RAL 9010		501,00	525,00	549,00	983,00
		081827	081834	081841	081858 *
MZ 11 Mechově zelená RAL 6005		501,00	525,00	549,00	983,00
		081988	081995	082008	082015 *
ZS 12 Zinkově šedá RAL extra		501,00	525,00	549,00	983,00
		082183	082190	082206	082213 *
PZ 13 Patina zelená RAL extra				600,00	
				112750	
PM 14 Patina měděná RAL extra				600,00	
				112743	
Hliník 15 Natur	451,00	451,00	473,00	495,00	884,00
	000569 *	000576 *	000583 *	000590 *	000606 *
Balení v ks 	5	5	5	5	5
Balení v ks 	150	150	150	150	150

* Výroba na objednávku



ČELO ŽLABOVÉ

W-WCL



Jmenovitá velikost	200	250	280	333	400
Cena v CZK/ks	S DPH	S DPH	S DPH	S DPH	S DPH
AN 1 Antracit RAL 7016	51,00 085856 *	51,00 085863	53,00 085870	54,00 085887	81,00 085894
TM 2 Testa di Moro RAL 8028	51,00 086228 *	51,00 086235	53,00 086242	54,00 086259	81,00 086266
SS 3 Světle šedá RAL 7005		51,00 086181	53,00 086198	54,00 086204	81,00 086211
ZH 4 Zeleno hnědá RAL 7013		51,00 086273	53,00 086280	54,00 086297	81,00 086303
BH 5 Bílo hliníková RAL 9006		51,00 085948	53,00 085955	54,00 085962	81,00 085979
BHT 6 Bílo hliníková tmavá RAL 9007		51,00 101419 *	53,00 101426 *	54,00 101433	81,00 080257 *
MH 7 Měděno hnědá RAL 8004		51,00 086020	53,00 086037	54,00 086044	81,00 086051
IC 8 Intenzivní černá RAL 9005		51,00 085986	53,00 085993	54,00 086006	81,00 086013 *
OC 9 Ocelově červená RAL 3009		51,00 086105	53,00 086112	54,00 086129	81,00 086136
B 10 Bílá RAL 9010		51,00 085900	53,00 085917	54,00 085924	81,00 085931 *
MZ 11 Mechově zelená RAL 6005		51,00 086068	53,00 086075	54,00 086082	81,00 086099 *
ZS 12 Zinkově šedá RAL extra		51,00 086310	53,00 086327 *	54,00 086334	81,00 086341 *
PZ 13 Patina zelená RAL extra				136,00 086174	
PM 14 Patina měděná RAL extra				136,00 086150	
Hliník 15 Natur		46,00 085818	47,00 085825	49,00 085832	73,00 085849
Balení v ks 	6/60	6/60	6/60	6/60	4/40
Balení v ks 	1 440	1 440	1 440	1 440	960

* Výroba na objednávku



KOTLÍK ŽLABOVÝ

W-WKL



Jmenovitá velikost	200/60	250/60	250/80	280/80	280/100
Cena v CZK/ks	S DPH	S DPH	S DPH	S DPH	S DPH
AN 1 Antracit RAL 7016	339,00 078278	359,00 078285	383,00 078292	440,00 078308	424,00 078315
TM 2 Testa di Moro RAL 8028	339,00 079152	359,00 079169	383,00 079176	440,00 079183	424,00 079190
SS 3 Světle šedá RAL 7005	339,00 079046 *	359,00 079053 *	383,00 079060	440,00 079077	424,00 079084
ZH 4 Zeleno hnědá RAL 7013	339,00 079268 *	359,00 079275	383,00 079282	440,00 079299	424,00 079305
BH 5 Bílo hliníková RAL 9006	339,00 078490 *	359,00 078506 *	383,00 078513	440,00 078520	424,00 078537
BHT 6 Bílo hliníková tmavá RAL 9007			383,00 101594	440,00 101600 *	424,00 101617 *
MH 7 Měděno hnědá RAL 8004	339,00 078711 *	359,00 078728 *	383,00 078735	440,00 078742	424,00 078759
IC 8 Intenzivní černá RAL 9005	339,00 078605 *	359,00 078612 *	383,00 078629	440,00 078636	424,00 078643
OC 9 Ocelově červená RAL 3009	339,00 078964 *	359,00 078933 *	383,00 078940	440,00 078957	424,00 078971
B 10 Bílá RAL 9010	339,00 078384 *	359,00 078391 *	383,00 078407	440,00 078414	424,00 078421
MZ 11 Mechově zelená RAL 6005	339,00 078827 *	359,00 078834 *	383,00 078841	440,00 078858	424,00 078865
ZS 12 Zinkově šedá RAL extra	339,00 079374 *	359,00 079381 *	383,00 079398	440,00 079404	424,00 079411
PZ 13 Patina zelená RAL extra					
PM 14 Patina měděná RAL extra					
Hliník 15 Natur	305,00 078162 *	324,00 078179 *	346,00 078186	396,00 078193	381,00 078223
Balení v ks 	20	20	20	20	20
Balení v ks 	600	600	600	600	600

* Výroba na objednávku



KOTLÍK ŽLABOVÝ

W-WKL



Jmenovitá velikost	333/80	333/100	333/120
Cena v CZK/ks	S DPH	S DPH	S DPH
AN 1 Antracit RAL 7016	454,00 078322	464,00 078339	610,00 078346
TM 2 Testa di Moro RAL 8028	454,00 079206	464,00 079213	610,00 079220
SS 3 Světle šedá RAL 7005	454,00 079091 *	464,00 079107	610,00 079114
ZH 4 Zeleno hnědá RAL 7013	454,00 079312 *	464,00 079336	610,00 079329
BH 5 Bílo hliníková RAL 9006	454,00 078544	464,00 078551	610,00 078568
BHT 6 Bílo hliníková tmavá RAL 9007	454,00 101624 *	464,00 101631	610,00 101648 *
MH 7 Měděno hnědá RAL 8004	454,00 078766 *	464,00 078773	610,00 078780
IC 8 Intenzivní černá RAL 9005	454,00 078650 *	464,00 078667	610,00 078674
OC 9 Ocelově červená RAL 3009	454,00 078988 *	464,00 078995	610,00 079015
B 10 Bílá RAL 9010	454,00 078438	464,00 078445	610,00 078452
MZ 11 Mechově zelená RAL 6005	454,00 078872 *	464,00 078889	610,00 078896
ZS 12 Zinkově šedá RAL extra	454,00 079428 *	464,00 079435	610,00 079442
PZ 13 Patina zelená RAL extra		650,00 112675	
PM 14 Patina měděná RAL extra		650,00 112668	
Hliník 15 Natur	408,00 078209	418,00 078230	549,00 078216
Balení v ks 	20	20	15
Balení v ks 	600	600	300

* Výroba na objednávku



KOTLÍK ŽLABOVÝ

W-WKL

Jmenovitá velikost	400/100	400/120	400/150
Cena v CZK/ks	S DPH	S DPH	S DPH
AN 1 Antracit RAL 7016	634,00 078353 *	678,00 078360	1 186,00 078377 *
TM 2 Testa di Moro RAL 8028	634,00 079237 *	678,00 079244	1 186,00 079251 *
SS 3 Světle šedá RAL 7005	634,00 079121 *	678,00 079138	1 186,00 079145 *
ZH 4 Zeleno hnědá RAL 7013	634,00 079343 *	678,00 079350	1 186,00 079367
BH 5 Bílo hliníková RAL 9006	634,00 078575 *	678,00 078582	1 186,00 078599 *
BHT 6 Bílo hliníková tmavá RAL 9007		678,00 080288 *	
MH 7 Měděno hnědá RAL 8004	634,00 078797 *	678,00 078803	1 186,00 078810 *
IC 8 Intenzivní černá RAL 9005	634,00 078681 *	678,00 078698	1 186,00 078704 *
OC 9 Ocelově červená RAL 3009	634,00 079008 *	678,00 079022 *	1 186,00 079039 *
B 10 Bílá RAL 9010	634,00 078469 *	678,00 078476	1 186,00 078483 *
MZ 11 Mechově zelená RAL 6005	634,00 078902 *	678,00 078919	1 186,00 078926 *
ZS 12 Zinkově šedá RAL extra	634,00 079459 *	678,00 079466	1 186,00 079473 *
PZ 13 Patina zelená RAL extra			
PM 14 Patina měděná RAL extra			
Hliník 15 Natur	571,00 078247 *	610,00 078254	1 067,00 078261 *
Balení v ks 	15	15	15
Balení v ks 	300	300	300

* Výroba na objednávku



NOVÝ UPINACÍ
SYSTÉM FEDER UMOŽŇUJE
JEDNODUŠE NATOČIT KOLENO
DO POŽADOVANÉHO SMĚRU,
SPOLEHLIVĚ DRŽÍ V KAŽDÉ
POLOZE. SNADNÁ MONTÁŽ
NA JAKÉKOLIV KOLENO
BEZ NÝTOVÁNÍ.



1



2



3

ALUMINIUM
POLYESTER + NATUR







ALUMINIUM

POLYESTER + NATUR

NEREZOVÝ LPAČ LISTÍ

N-NZN





Jmenovitá velikost	EAN číslo výrobku	Balení v ks		Cena s DPH [CZK/ks]
				
60	001153	30	2 160	188,00
80	001160	20	1 440	190,00
100	001177	15	1 080	193,00
120	001184	10	720	210,00
150	001191	5	360	332,00



SBĚRNÝ KOTLÍK DESIGN

W-WKLZ DE

Jmenovitá velikost	80	100	120
Cena v CZK/ks	S DPH	S DPH	S DPH
AN 1 Antracit RAL 7016	3 385,00 031044 *	3 385,00 031068	3 557,00 031082 *
TM 2 Testa di Moro RAL 8028	3 385,00 032249 *	3 385,00 032263	3 557,00 032287 *
SS 3 Světle šedá RAL 7005	3 385,00 032096 *	3 385,00 032119	3 557,00 032133 *
ZH 4 Zeleno hnědá RAL 7013	3 385,00 032393 *	3 385,00 032416	3 557,00 032430 *
BH 5 Bílo hliníková RAL 9006	3 385,00 031341 *	3 385,00 031365	3 557,00 031389 *
BHT 6 Bílo hliníková tmavá RAL 9007			
MH 7 Měděno hnědá RAL 8004	3 385,00 031648 *	3 385,00 031662 *	3 557,00 031686 *
IC 8 Intenzivní černá RAL 9005	3 385,00 031495 *	3 385,00 031518	3 557,00 031532 *
OC 9 Ocelově červená RAL 3009	3 385,00 031945 *	3 385,00 031969 *	3 557,00 031983 *
B 10 Bílá RAL 9010	3 385,00 031198 *	3 385,00 031211	3 557,00 031235 *
MZ 11 Mechově zelená RAL 6005	3 385,00 031792 *	3 385,00 031815 *	3 557,00 031839 *
ZS 12 Zinkově šedá RAL extra	3 385,00 032546 *	3 385,00 032560 *	3 557,00 032584 *
PZ 13 Patina zelená RAL extra			
PM 14 Patina měděná RAL extra			
Hliník 15 Natur	3 046,00 030894 *	3 046,00 030917 *	3 202,00 030931 *
Balení v ks 	2	2	2
Balení v ks 	36	36	36



* Výroba na objednávku



SBĚRNÝ KOTLÍK DESIGN EXZENTRICKÝ

W-WKLZ DX





Jmenovitá velikost	80	100	120
Cena v CZK/ks	S DPH	S DPH	S DPH
AN 1 Antracit RAL 7016	3 896,00 031105 *	3 896,00 031136	4 235,00 031167
TM 2 Testa di Moro RAL 8028	3 896,00 032300 *	3 896,00 032331 *	4 235,00 032362 *
SS 3 Světle šedá RAL 7005	3 896,00 032157	3 896,00 032188	4 235,00 032218 *
ZH 4 Zeleno hnědá RAL 7013	3 896,00 032454 *	3 896,00 032485 *	4 235,00 032515 *
BH 5 Bílo hliníková RAL 9006	3 896,00 031402 *	3 896,00 031433 *	4 235,00 031464 *
BHT 6 Bílo hliníková tmavá RAL 9007	3 896,00 101655 *	3 896,00 101679 *	4 235,00 101693 *
MH 7 Měděno hnědá RAL 8004	3 896,00 031709 *	3 896,00 031730 *	4 235,00 031761 *
IC 8 Intenzivní černá RAL 9005	3 896,00 031556 *	3 896,00 031587 *	4 235,00 031617 *
OC 9 Ocelově červená RAL 3009	3 896,00 032003 *	3 896,00 032034 *	4 235,00 032065 *
B 10 Bílá RAL 9010	3 896,00 031259 *	3 896,00 031280 *	4 235,00 031310 *
MZ 11 Mechově zelená RAL 6005	3 896,00 031853 *	3 896,00 031884 *	4 235,00 031914 *
ZS 12 Zinkově šedá RAL extra	3 896,00 032607 *	3 896,00 032638 *	4 235,00 032669 *
PZ 13 Patina zelená RAL extra			
PM 14 Patina měděná RAL extra			
Hliník 15 Natur	3 507,00 030955 *	3 727,00 030986 *	3 812,00 031013 *
Balení v ks 	2	2	2
Balení v ks 	36	36	36

* Výroba na objednávku

SBĚRNÝ KOTLÍK KUBICKÝ

W-WKLZ KU



Jmenovitá velikost	80	100	120
Cena v CZK/ks	S DPH	S DPH	S DPH
AN 1 Antracit RAL 7016	4 337,00 031051 *	4 337,00 031075	4 913,00 031099 *
TM 2 Testa di Moro RAL 8028	4 337,00 032256 *	4 337,00 032270 *	4 913,00 032294 *
SS 3 Světle šedá RAL 7005	4 337,00 032102 *	4 337,00 032126 *	4 913,00 032140 *
ZH 4 Zeleno hnědá RAL 7013	4 337,00 032409 *	4 337,00 032423 *	4 913,00 032447 *
BH 5 Bílo hliníková RAL 9006	4 337,00 031358 *	4 337,00 031372 *	4 913,00 031396 *
BHT 6 Bílo hliníková tmavá RAL 9007			
MH 7 Měděno hnědá RAL 8004	4 337,00 031655 *	4 337,00 031679 *	4 913,00 031693 *
IC 8 Intenzivní černá RAL 9005	4 337,00 031501 *	4 337,00 031525 *	4 913,00 031549 *
OC 9 Ocelově červená RAL 3009	4 337,00 031952 *	4 337,00 031976 *	4 913,00 031990 *
B 10 Bílá RAL 9010	4 337,00 031204 *	4 337,00 031228 *	4 913,00 031242 *
MZ 11 Mechově zelená RAL 6005	4 337,00 031808 *	4 337,00 031822 *	4 913,00 031846 *
ZS 12 Zinkově šedá RAL extra	4 337,00 032553 *	4 337,00 032577 *	4 913,00 032591 *
PZ 13 Patina zelená RAL extra			
PM 14 Patina měděná RAL extra			
Hliník 15 Natur	3 903,00 030900 *	3 903,00 030924 *	4 421,00 030948 *
Balení v ks 	2	2	2
Balení v ks 	36	36	36

* Výroba na objednávku



SBĚRNÝ KOTLÍK KUBICKÝ EXZENTRICKÝ

W-WKLZ KX

Jmenovitá velikost	80	100	120
Cena v CZK/ks	S DPH	S DPH	S DPH
AN 1 Antracit RAL 7016	4 574,00 031112 *	4 574,00 031143	4 913,00 031174 *
TM 2 Testa di Moro RAL 8028	4 574,00 032317 *	4 574,00 032348 *	4 913,00 032379 *
SS 3 Světle šedá RAL 7005	4 574,00 032164 *	4 574,00 032195 *	4 913,00 032225 *
ZH 4 Zeleno hnědá RAL 7013	4 574,00 032461 *	4 574,00 032492 *	4 913,00 032522 *
BH 5 Bílo hliníková RAL 9006	4 574,00 031419 *	4 574,00 031440 *	4 913,00 031471 *
BHT 6 Bílo hliníková tmavá RAL 9007	4 574,00 101662 *	4 574,00 101686 *	4 913,00 101709 *
MH 7 Méděno hnědá RAL 8004	4 574,00 031716 *	4 574,00 031747 *	4 913,00 031778 *
IC 8 Intenzivní černá RAL 9005	4 574,00 031563 *	4 574,00 031594 *	4 913,00 031624 *
OC 9 Ocelově červená RAL 3009	4 574,00 032010 *	4 574,00 032041 *	4 913,00 032072 *
B 10 Bílá RAL 9010	4 574,00 031266 *	4 574,00 031297 *	4 913,00 031327 *
MZ 11 Mechově zelená RAL 6005	4 574,00 031860 *	4 574,00 031891 *	4 913,00 031921 *
ZS 12 Zinkově šedá RAL extra	4 574,00 032614 *	4 574,00 032645 *	4 913,00 032676 *
PZ 13 Patina zelená RAL extra			
PM 14 Patina měděná RAL extra			
Hliník 15 Natur	4 116,00 030962 *	4 116,00 030993 *	4 421,00 031020 *
Balení v ks 	2	2	2
Balení v ks 	36	36	36

* Výroba na objednávku



ALUMINIUM POLYESTER + NATUR

SBĚRNÝ KOTLÍK KUBICKÝ EXZENTRICKÝ S VÝTOKEM

W-WKLZ KXV

Jmenovitá velikost	80	100	120
Cena v CZK/ks	S DPH	S DPH	S DPH
AN 1 Antracit RAL 7016	5 421,00 031129 *	5 421,00 031150 *	5 760,00 031181 *
TM 2 Testa di Moro RAL 8028	5 421,00 032324 *	5 421,00 032355 *	5 760,00 032386 *
SS 3 Světle šedá RAL 7005	5 421,00 032171 *	5 421,00 032201 *	5 760,00 032232 *
ZH 4 Zeleno hnědá RAL 7013	5 421,00 032478 *	5 421,00 032508 *	5 760,00 032539 *
BH 5 Bílo hliníková RAL 9006	5 421,00 031426 *	5 421,00 031457 *	5 760,00 031488 *
BHT 6 Bílo hliníková tmavá RAL 9007			
MH 7 Méděno hnědá RAL 8004	5 421,00 031723 *	5 421,00 031754 *	5 760,00 031785 *
IC 8 Intenzivní černá RAL 9005	5 421,00 031570 *	5 421,00 031600 *	5 760,00 031631 *
OC 9 Ocelově červená RAL 3009	5 421,00 032027 *	5 421,00 032058 *	5 760,00 032089 *
B 10 Bílá RAL 9010	5 421,00 031273 *	5 421,00 031303 *	5 760,00 031334 *
MZ 11 Mechově zelená RAL 6005	5 421,00 031877 *	5 421,00 031907 *	5 760,00 031938 *
ZS 12 Zinkově šedá RAL extra	5 421,00 032621 *	5 421,00 032652 *	5 760,00 032683 *
PZ 13 Patina zelená RAL extra			
PM 14 Patina měděná RAL extra			
Hliník 15 Natur	4 879,00 030979 *	4 879,00 031006 *	5 184,00 031037 *
Balení v ks	2	2	2
Balení v ks	36	36	36



* Výroba na objednávku



TĚSNÍCI GUMA SBĚRNÉHO KOTLÍKA

P-PKLZ T



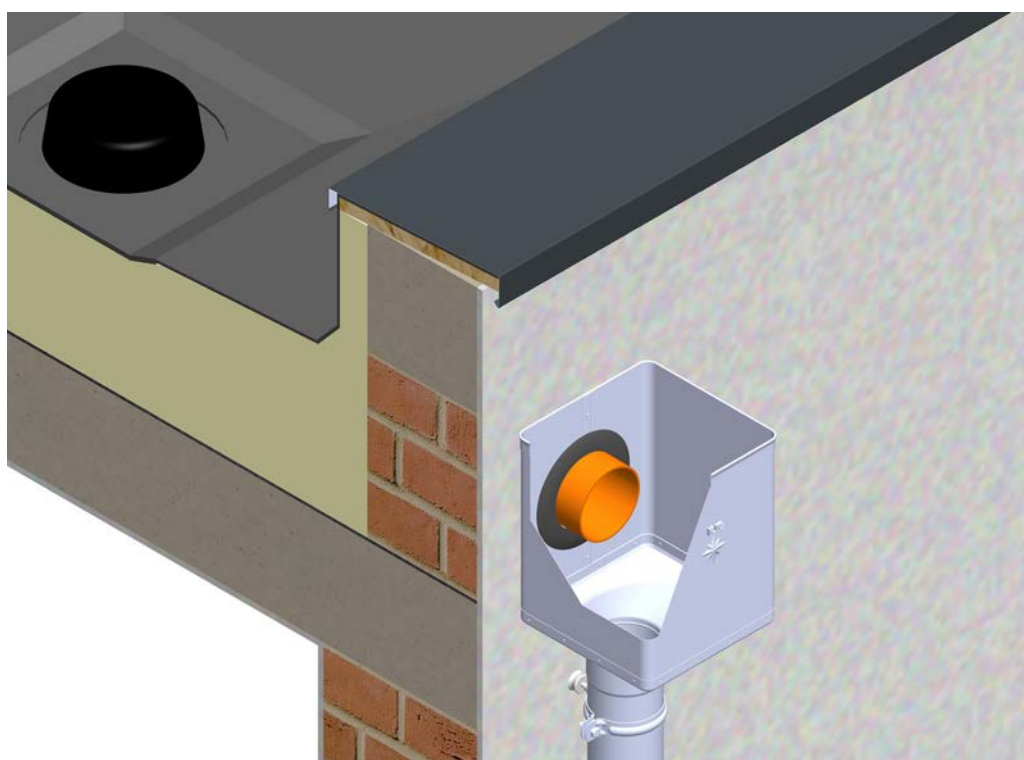

Jmenovitá velikost	EAN číslo výrobku	Balení v ks		Cena s DPH [CZK/ks]
				
IC 70-85	077103	5	600	136,00
IC 100-110	077110	5	600	139,00
IC 110-125	077097	5	600	142,00
PS 70-85	077134	5	600	152,00
PS 100-110	077141	5	600	166,00
PS 110-125	077127	5	600	169,00



SVODOVÉ KOLENO 72°

W-WK

Jmenovitá velikost	60	80	100	120	150
Cena v CZK/ks	S DPH	S DPH	S DPH	S DPH	S DPH
AN 1 Antracit RAL 7016	312,00 074294	305,00 074300	325,00 074324	495,00 074348	1 101,00 074362
TM 2 Testa di Moro RAL 8028	312,00 074935	305,00 074942	325,00 074966	495,00 074980	1 101,00 075000 *
SS 3 Světle šedá RAL 7005	312,00 074850 *	305,00 074867	325,00 074881	495,00 074904	1 101,00 074928 *
ZH 4 Zeleno hnědá RAL 7013	312,00 075017 *	305,00 075024	325,00 075048	495,00 075062	1 101,00 075086
BH 5 Bílo hliníková RAL 9006	312,00 074461	305,00 074454	325,00 074485	495,00 074508	1 101,00 074522 *
BHT 6 Bílo hliníková tmavá RAL 9007		305,00 101587	325,00 101563	495,00 101549 *	
MH 7 Měděno hnědá RAL 8004	312,00 074614	305,00 074621	325,00 074645	495,00 074669	1 101,00 074683 *
IC 8 Intenzivní černá RAL 9005	312,00 074539 *	305,00 074546	325,00 074560	495,00 074584	1 101,00 074607 *
OC 9 Ocelově červená RAL 3009	312,00 074775 *	305,00 074782	325,00 074805	495,00 074829	1 101,00 074843 *
B 10 Bílá RAL 9010	312,00 074379	305,00 074386	325,00 074409	495,00 074423	1 101,00 074447 *
MZ 11 Mechově zelená RAL 6005	312,00 074690 *	305,00 074706	325,00 074720	495,00 074744	1 101,00 074768 *
ZS 12 Zinkově šedá RAL extra	312,00 075093 *	305,00 075109	325,00 075123	495,00 075147	1 101,00 075161 *
PZ 13 Patina zelená RAL extra			312,00 112644		
PM 14 Patina měděná RAL extra			312,00 112620		
Hliník 15 Natur	274,00 074218	274,00 074225	302,00 074249	491,00 074263	983,00 074287 *
Balení v ks 	25	25	25	15	5
Balení v ks 	600	400	300	180	60



* Výroba na objednávku



SVODOVÉ KOLENO 85°

W-WKR





Jmenovitá velikost	80	100	120
Cena v CZK/ks	S DPH	S DPH	S DPH
AN 1 Antracit RAL 7016	379,00 074317	474,00 074331	610,00 074355 *
TM 2 Testa di Moro RAL 8028	379,00 074959	474,00 074973	610,00 074997 *
SS 3 Světle šedá RAL 7005	379,00 074874 *	474,00 074898	610,00 074911 *
ZH 4 Zeleno hnědá RAL 7013	379,00 075031 *	474,00 075055	610,00 075079 *
BH 5 Bilo hliníková RAL 9006	379,00 074478 *	474,00 074492	610,00 074515 *
BHT 6 Bilo hliníková tmavá RAL 9007	379,00 101570 *	474,00 101556 *	610,00 101532 *
MH 7 Měděno hnědá RAL 8004	379,00 074638 *	474,00 074652	610,00 074676 *
IC 8 Intenzivní černá RAL 9005	379,00 074553 *	474,00 074577 *	610,00 074591 *
OC 9 Ocelově červená RAL 3009	379,00 074799 *	474,00 074812 *	610,00 074836 *
B 10 Bílá RAL 9010	379,00 074393	474,00 074416	610,00 074430 *
MZ 11 Mechově zelená RAL 6005	379,00 074713 *	474,00 074737 *	610,00 074751 *
ZS 12 Zinkově šedá RAL extra	379,00 075116 *	474,00 075130 *	610,00 075154 *
PZ 13 Patina zelená RAL extra		332,00 112651	
PM 14 Patina měděná RAL extra		332,00 112637	
Hliník 15 Natur	342,00 074232 *	427,00 074256	549,00 074270 *
Balení v ks 	25	25	15
Balení v ks 	400	300	180

* Výroba na objednávku

SVODOVÉ KOLENO TUPÉ 40°

W-WKT

Jmenovitá velikost	80	100	120
Cena v CZK/ks	S DPH	S DPH	S DPH
AN 1 Antracit RAL 7016	302,00 081414	373,00 081421	505,00 081438
TM 2 Testa di Moro RAL 8028	302,00 081650	373,00 081667	505,00 081674 *
SS 3 Světle šedá RAL 7005	302,00 081629	373,00 081636	505,00 081643
ZH 4 Zeleno hnědá RAL 7013	302,00 081681	373,00 081698	505,00 081704
BH 5 Bilo hliníková RAL 9006	302,00 081476	373,00 081483	505,00 081490 *
BHT 6 Bilo hliníková tmavá RAL 9007	302,00 101778 *	373,00 101785 *	505,00 101792 *
MH 7 Měděno hnědá RAL 8004	302,00 081537	373,00 081544	505,00 081551 *
IC 8 Intenzivní černá RAL 9005	302,00 081506 *	373,00 081513 *	505,00 081520 *
OC 9 Ocelově červená RAL 3009	302,00 081599 *	373,00 081605	505,00 081612 *
B 10 Bílá RAL 9010	302,00 081445	373,00 081452	505,00 081469
MZ 11 Mechově zelená RAL 6005	302,00 081568	373,00 081575	505,00 081582
ZS 12 Zinkově šedá RAL extra	302,00 081711	373,00 081728	505,00 081735
PZ 13 Patina zelená RAL extra			
PM 14 Patina měděná RAL extra			
Hliník 15 Natur	271,00 081384	335,00 081391	473,00 081407
Balení v ks 	25	25	15
Balení v ks 	400	300	240

* Výroba na objednávku



SVODOVÁ ROURA [s=0,70]

W-WZR

Jmenovitá velikost	60	80	80	80
Délka v m	2,0	3,0	4,0	6,0
Cena v CZK/m	S DPH	S DPH	S DPH	S DPH
AN 1 Antracit RAL 7016	296,00 050106	251,00 050113	251,00 050120	251,00 050137 *
TM 2 Testa di Moro RAL 8028	296,00 050762	251,00 050779	251,00 050786	251,00 050793 *
SS 3 Světle šedá RAL 7005	296,00 050687	251,00 050694	251,00 050700	251,00 052032 *
ZH 4 Zeleno hnědá RAL 7013	296,00 050861	251,00 050878	251,00 051059	251,00 050892 *
BH 5 Bílo hliníková RAL 9006	296,00 050281	251,00 050298	251,00 050304	251,00 098283 *
BHT 6 Bílo hliníková tmavá RAL 9007		251,00 101952 *		
MH 7 Měděno hnědá RAL 8004	296,00 050441 *	251,00 050458	251,00 050465	
IC 8 Intenzivní černá RAL 9005	296,00 050366 *	251,00 050373	251,00 050380	
OC 9 Ocelově červená RAL 3009	296,00 050601	251,00 050618	251,00 050625 *	
B 10 Bílá RAL 9010	296,00 050205	251,00 050212	251,00 050229	
MZ 11 Mechově zelená RAL 6005	296,00 050526	251,00 050533	251,00 050540	
ZS 12 Zinkově šedá RAL extra	296,00 050960 *	251,00 050977	251,00 050984 *	
PZ 13 Patina zelená RAL extra				
PM 14 Patina měděná RAL extra				
Hliník 15 Natur	237,00 050021	213,00 050038	213,00 050045	213,00 052070 *
Balení v m 	10	18	24	30
Balení v m 	490	216	288	750

* Výroba na objednávku



SVODOVÁ ROURA [s=0,70]

W-WZR



Jmenovitá velikost	100	100	100
Délka v m	3,0	4,0	6,0
Cena v CZK/m	S DPH	S DPH	S DPH
AN 1 Antracit RAL 7016	271,00 050144	271,00 050151	271,00 050168 *
TM 2 Testa di Moro RAL 8028	271,00 050809	271,00 050816	271,00 050823 *
SS 3 Světle šedá RAL 7005	271,00 050717	271,00 050724	271,00 052049 *
ZH 4 Zeleno hnědá RAL 7013	271,00 050908	271,00 050915	271,00 050922 *
BH 5 Bílo hliníková RAL 9006	271,00 050311	271,00 050328	271,00 052056 *
BHT 6 Bílo hliníková tmavá RAL 9007	271,00 101969	271,00 101976	
MH 7 Měděno hnědá RAL 8004	271,00 050472	271,00 050489	
IC 8 Intenzivní černá RAL 9005	271,00 050397	271,00 050403	
OC 9 Ocelově červená RAL 3009	271,00 050632	271,00 050649	
B 10 Bílá RAL 9010	271,00 050236	271,00 050243	
MZ 11 Mechově zelená RAL 6005	271,00 050557	271,00 050564	
ZS 12 Zinkově šedá RAL extra	271,00 050991	271,00 051004	
PZ 13 Patina zelená RAL extra	379,00 112828	379,00 112835 *	
PM 14 Patina měděná RAL extra	379,00 112804	379,00 112811 *	
Hliník 15 Natur	247,00 050052	247,00 050069	247,00 052025 *
Balení v m 	18	24	30
Balení v m 	180	240	480

* Výroba na objednávku



SVODOVÁ ROURA [s=0,70]

W-WZR

Jmenovitá velikost	120	120	120	150
Délka v m	3,0	4,0	6,0	3,0
Cena v CZK/m	S DPH	S DPH	S DPH	S DPH
AN 1 Antracit RAL 7016	373,00	373,00		581,00
	050175	050182		050199 *
TM 2 Testa di Moro RAL 8028	373,00	373,00	373,00	581,00
	050830	050847	052063 *	050854 *
SS 3 Světle šedá RAL 7005	373,00	373,00		581,00
	050731	050748		050755 *
ZH 4 Zeleno hnědá RAL 7013	373,00	373,00		581,00
	050939	050946		050953 *
BH 5 Bílo hliníková RAL 9006	373,00	373,00		581,00
	050335	050342		050359 *
BHT 6 Bílo hliníková tmavá RAL 9007	373,00			
	101983			
MH 7 Měděno hnědá RAL 8004	373,00	373,00		581,00
	050496	050502		050519 *
IC 8 Intenzivní černá RAL 9005	373,00	373,00		581,00
	050410	050427		050434 *
OC 9 Ocelově červená RAL 3009	373,00	373,00		581,00
	050656	050663		050670 *
B 10 Bílá RAL 9010	373,00	373,00		581,00
	050250	050267		050274 *
MZ 11 Mechově zelená RAL 6005	373,00	373,00		581,00
	050571	050588		050595 *
ZS 12 Zinkově šedá RAL extra	373,00	373,00		581,00
	051011 *	051028		051035 *
PZ 13 Patina zelená RAL extra				
PM 14 Patina měděná RAL extra				
Hliník 15 Natur	312,00	312,00		488,00
	050076	050083		050090 *
Balení v m 	18	24	30	3
Balení v m 	144	192	-	84

* Výroba na objednávku





ALUMINIUM

POLYESTER + NATUR



PLASTOVÝ SVODOVÝ RUKÁV

SD-ZR FOLIA KJG

Jmenovitá velikost	Délka v m	EAN číslo výrobku	Balení v m		Cena s DPH [CZK/m]
60 – 150	100,0	139726	100	6 000	13,00

KOLENO SOKLOVÉ

W-WKO





Jmenovitá velikost	80	100	120
Cena v CZK/ks	S DPH	S DPH	S DPH
AN 1 Antracit RAL 7016	373,00 063328	457,00 008411	542,00 011985
TM 2 Testa di Moro RAL 8028	373,00 023353	457,00 023377	542,00 023421
SS 3 Světle šedá RAL 7005	373,00 023230	457,00 023285	542,00 023919
ZH 4 Zeleno hnědá RAL 7013	373,00 023476	457,00 023513	542,00 023537
BH 5 Bílo hliníková RAL 9006	373,00 064837	457,00 057877	542,00 057884
BHT 6 Bílo hliníková tmavá RAL 9007	373,00 101716	457,00 101723	542,00 101730 *
MH 7 Méděno hnědá RAL 8004	373,00 000316	457,00 000330	542,00 048738
IC 8 Intenzivní černá RAL 9005	373,00 057891	457,00 057907	542,00 048226 *
OC 9 Ocelově červená RAL 3009	373,00 000507	457,00 068712	542,00 023209
B 10 Bílá RAL 9010	373,00 012029	457,00 013804	542,00 013811
MZ 11 Mechově zelená RAL 6005	373,00 011923	457,00 000453	542,00 000477
ZS 12 Zinkově šedá RAL extra	373,00 023582	457,00 023629	542,00 023650
PZ 13 Patina zelená RAL extra		573,00 112699	
PM 14 Patina méděná RAL extra		573,00 112682	
Hliník 15 Natur	335,00 077165	412,00 077172	488,00 077189
Balení v ks 📦	20	20	15
Balení v ks 🚚	320	240	180

* Výroba na objednávku

SVODOVÁ ODBOČKA 72°

W-WZO

Jmenovitá velikost	80/80	100/80	100/100
Cena v CZK/ks	S DPH	S DPH	S DPH
AN 1 Antracit RAL 7016	1 304,00 096630 *	1 338,00 096647 *	1 352,00 096654
TM 2 Testa di Moro RAL 8028	1 304,00 110473 *	1 338,00 110480 *	1 352,00 110497
SS 3 Světle šedá RAL 7005	1 304,00 110404 *	1 338,00 110411 *	1 352,00 110428 *
ZH 4 Zeleno hnědá RAL 7013	1 304,00 110541 *	1 338,00 110558 *	1 352,00 110565
BH 5 Bilo hliníková RAL 9006	1 304,00 110053 *	1 338,00 110060 *	1 352,00 110077 *
BHT 6 Bilo hliníková tmavá RAL 9007	1 304,00 096555 *	1 338,00 096623 *	1 352,00 109972 *
MH 7 Méděno hnědá RAL 8004	1 304,00 110190 *	1 338,00 110206 *	1 352,00 110213 *
IC 8 Intenzivní černá RAL 9005	1 304,00 110121 *	1 338,00 110138 *	1 352,00 110145 *
OC 9 Ocelově červená RAL 3009	1 304,00 110336 *	1 338,00 110343 *	1 352,00 110350 *
B 10 Bílá RAL 9010	1 304,00 109989 *	1 338,00 109996 *	1 352,00 110008 *
MZ 11 Mechově zelená RAL 6005	1 304,00 110268 *	1 338,00 110275 *	1 352,00 110282
ZS 12 Zinkově šedá RAL extra	1 304,00 110619 *	1 338,00 110626 *	1 352,00 110633 *
PZ 13 Patina zelená RAL extra			
PM 14 Patina měděná RAL extra			
Hliník 15 Natur	1 172,00 096562 *	1 203,00 096579	1 216,00 096586
Balení v ks 	4	3	4
Balení v ks 	90	90	120



* Výroba na objednávku



SVODOVÁ ODBOČKA 72°

W-WZO





Jmenovitá velikost	120/80	120/100	120/120
Cena v CZK/ks	S DPH	S DPH	S DPH
AN 1 Antracit RAL 7016	1 457,00 096661 *	1 477,00 096678 *	1 487,00 096685 *
TM 2 Testa di Moro RAL 8028	1 457,00 110503 *	1 477,00 110510 *	1 487,00 110527 *
SS 3 Světle šedá RAL 7005	1 457,00 110435 *	1 477,00 110442 *	1 487,00 110459 *
ZH 4 Zeleno hnědá RAL 7013	1 457,00 110572 *	1 477,00 110589 *	1 487,00 110596 *
BH 5 Bílo hliníková RAL 9006	1 457,00 110084 *	1 477,00 110091 *	1 487,00 110107 *
BHT 6 Bílo hliníková tmavá RAL 9007	1 457,00 110046 *	1 477,00 110114 *	1 487,00 110183 *
MH 7 Měděno hnědá RAL 8004	1 457,00 110220 *	1 477,00 110237 *	1 487,00 110244 *
IC 8 Intenzivní černá RAL 9005	1 457,00 110152 *	1 477,00 110169 *	1 487,00 110176 *
OC 9 Ocelově červená RAL 3009	1 457,00 110367 *	1 477,00 110374 *	1 487,00 110381 *
B 10 Bílá RAL 9010	1 457,00 110015 *	1 477,00 110022 *	1 487,00 110039 *
MZ 11 Mechově zelená RAL 6005	1 457,00 110299 *	1 477,00 110305 *	1 487,00 110312 *
ZS 12 Zinkově šedá RAL extra	1 457,00 110640 *	1 477,00 110657 *	1 487,00 110664 *
PZ 13 Patina zelená RAL extra			
PM 14 Patina měděná RAL extra			
Hliník 15 Natur	1 311,00 096593 *	1 331,00 096609 *	1 338,00 096616 *
Balení v ks 	3	3	3
Balení v ks 	90	90	90

* Výroba na objednávku

SVODOVÁ OBJÍMKA M10

W-WOB

Jmenovitá velikost	60	80	100	120	150
Cena v CZK/ks	S DPH	S DPH	S DPH	S DPH	S DPH
AN 1 Antracit RAL 7016	120,00 054982	113,00 054999	115,00 055002	132,00 055019	198,00 055026
TM 2 Testa di Moro RAL 8028	120,00 055439	113,00 055446	115,00 055453	132,00 055460	198,00 055477 *
SS 3 Světle šedá RAL 7005	120,00 055330 *	113,00 055347	115,00 055354	132,00 055361	198,00 055378 *
ZH 4 Zeleno hnědá RAL 7013	120,00 055514	113,00 055521	115,00 055538	132,00 055545	198,00 055552 *
BH 5 Bílo hliníková RAL 9006	120,00 055088	113,00 055095	115,00 055101	132,00 055118	198,00 055125 *
BHT 6 Bílo hliníková tmavá RAL 9007		113,00 101808	115,00 101815	132,00 101822 *	
MH 7 Měděno hnědá RAL 8004	120,00 055187 *	113,00 055194	115,00 055200	132,00 055217	198,00 055224 *
IC 8 Intenzivní černá RAL 9005	120,00 055132 *	113,00 055149	115,00 055156	132,00 055163	198,00 055170 *
OC 9 Ocelově červená RAL 3009	120,00 055286 *	113,00 055293	115,00 055309	132,00 055316	198,00 055323 *
B 10 Bílá RAL 9010	120,00 055033	113,00 055040	115,00 055057	132,00 055064	198,00 055071 *
MZ 11 Mechově zelená RAL 6005	120,00 055231 *	113,00 055248	115,00 055255	132,00 055262	198,00 055279 *
ZS 12 Zinkově šedá RAL extra	120,00 055569 *	113,00 055576	115,00 055583	132,00 055590	198,00 055606 *
PZ 13 Patina zelená RAL extra			281,00 112712		
PM 14 Patina měděná RAL extra			281,00 112705		
Hliník 15 Natur	95,00 054906 *	88,00 054913	91,00 054920	102,00 054937	158,00 054944 *
Balení v ks 	25	25	25	25	20
Balení v ks 	3 000	3 000	3 000	3 000	2 400



* Výroba na objednávku



NEREZOVÝ ŠROUB PRO OBJÍMKY M8x30

P-POB-NSK





Jmenovitá velikost	EAN číslo výrobku	Balení v ks		Cena s DPH [CZK/ks]
				
M8 x 30 *	139658	1	–	8,00

* Výroba na objednávku

ŠROUB PRO OBJÍMKU SE ZÁVITOVOU MATKOU TORX M10

P-POB-HT





Jmenovitá velikost	EAN číslo výrobku	Balení v ks		Cena s DPH [CZK/ks]
				
80	002464	100	40 000	34,00
140	002471	100	28 000	42,00
200	002488	100	20 000	53,00
250	002495	100	16 000	58,00
300	002501	100	11 200	58,00

ALUMINIUM
POLYESTER + NATUR

HMOŽDINKA BEZ LAMELY M10

P-POB-HN DB





Jmenovitá velikost	EAN číslo výrobku	Balení v ks		Cena s DPH [CZK/ks]
				
120	002426	100	25 000	14,00

HMOŽDINKA S LAMELOU M10

P-POB-HN DB





Jmenovitá velikost	EAN číslo výrobku	Balení v ks		Cena s DPH [CZK/ks]
				
180	002433	100	12 000	14,00
240	002440	100	12 000	17,00
280	002457	100	12 000	18,00

KOMBISKRUTKA TORX M10

P-POB-ZT/SZ



Jmenovitá velikost	EAN číslo výrobku	Balení v ks		Cena s DPH [CZK/ks]
				
140	002587	50	10 400	15,00
180	002594	50	10 400	19,00



ALUMINIUM

POLYESTER + NATUR

IZOLAČNÍ HMOŽDINKA M10

P-POB-HN IZOL





Jmenovitá velikost	EAN číslo výrobku	Balení v ks		Cena s DPH [CZK/ks]
				
M10 x 96	001207	25	2 625	100,00

ZÁVITOVÁ TYČ M10

P-POB-ZT





Jmenovitá velikost	EAN číslo výrobku	Balení v ks		Cena s DPH [CZK/ks]
				
60	002556	100	20 800	7,00
100	002563	100	15 600	10,00
150	002570	50	10 400	19,00

MONTÁŽNÍ PLATNA M10

P-POB-ZT MP













Jmenovitá velikost	EAN číslo výrobku	Balení v ks		Cena s DPH [CZK/ks]
				
80 x 30	002518	25	5 200	39,00

KRYTKA PRO ŠROUB OBJÍMKY

P-POB-HT AKG





Jmenovitá velikost	EAN číslo výrobku	Balení v ks		Cena s DPH [CZK/ks]
				
 29 x 13	002280	50	16 800	8,00
 29 x 13	002211	50	16 800	8,00
 29 x 13	002235	50	16 800	8,00
 29 x 13	002266	50	16 800	8,00
 29 x 13	002242	50	16 800	8,00
 29 x 13	002228	50	16 800	8,00
 29 x 13	002273	50	16 800	8,00
 29 x 13	002259	50	16 800	8,00
 29 x 13	002297	50	16 800	8,00

DEŠŤOVÁ KLAPKA



W-WZV



Jmenovitá velikost	80	100	120
Cena v CZK/ks	S DPH	S DPH	S DPH
AN 1 Antracit RAL 7016	711,00 035073	745,00 035080	1 016,00 035097
TM 2 Testa di Moro RAL 8028	711,00 035103	745,00 035110	1 016,00 035127
ZH 4 Zeleno hnědá RAL 7013	711,00 035134	745,00 035141	1 016,00 035158
Balení v ks 	6	5	3
Balení v ks 	180	150	90

DEŠŤOVÁ KLAPKA S LAPAČEM LISTÍ

W-WZVS



Jmenovitá velikost	80	100	120
Cena v CZK/ks	S DPH	S DPH	S DPH
AN 1 Antracit RAL 7016	864,00 035226	949,00 035233	1 423,00 035240
TM 2 Testa di Moro RAL 8028	864,00 035462	949,00 035479	1 423,00 035486
SS 3 Světle šedá RAL 7005	864,00 035431	949,00 035448	1 423,00 035455
ZH 4 Zeleno hnědá RAL 7013	864,00 035493	949,00 035509	1 423,00 035516
BH 5 Bílo hliníková RAL 9006	864,00 035288	949,00 035295	1 423,00 035301
BHT 6 Bílo hliníková tmavá RAL 9007	864,00 102034 *	949,00 102041 *	1 423,00 102058 *
MH 7 Měděno hnědá RAL 8004	864,00 035349	949,00 035356	1 423,00 035363
IC 8 Intenzivní černá RAL 9005	864,00 035318	949,00 035325	1 423,00 035332 *
OC 9 Ocelově červená RAL 3009	864,00 035400	949,00 035417	1 423,00 035424
B 10 Bílá RAL 9010	864,00 035257	949,00 035264	1 423,00 035271
MZ 11 Mechově zelená RAL 6005	864,00 035370	949,00 035387	1 423,00 035394
ZS 12 Zinkově šedá RAL extra	864,00 035523	949,00 035530	1 423,00 035547
PZ 13 Patina zelená RAL extra			
PM 14 Patina měděná RAL extra			
Hliník 15 Natur	691,00 035196 *	759,00 035202	1 138,00 035219 *
Balení v ks 	6	5	3
Balení v ks 	180	150	90

* Výroba na objednávku



SBĚRAČ DEŠŤOVÉ VODY S HADICÍ



W-WZVHA

Jmenovitá velikost	80	100	120
Cena v CZK/ks	S DPH	S DPH	S DPH
AN 1 Antracit RAL 7016	2 202,00 018854	2 202,00 018861	4 235,00 018878 *
TM 2 Testa di Moro RAL 8028	2 202,00 019097	2 202,00 019103	4 235,00 019110
SS 3 Světle šedá RAL 7005	2 202,00 019066 *	2 202,00 019073	4 235,00 019080 *
ZH 4 Zeleno hnědá RAL 7013	2 202,00 019127 *	2 202,00 019134	4 235,00 019141 *
BH 5 Bílo hliníková RAL 9006	2 202,00 018915 *	2 202,00 018922	4 235,00 018939 *
BHT 6 Bílo hliníková tmavá RAL 9007	2 202,00 102003 *	2 202,00 102010 *	4 235,00 102027 *
MH 7 Měděno hnědá RAL 8004	2 202,00 018977 *	2 202,00 018984 *	4 235,00 018991 *
IC 8 Intenzivní černá RAL 9005	2 202,00 018946 *	2 202,00 018953	4 235,00 018960
OC 9 Ocelově červená RAL 3009	2 202,00 019035 *	2 202,00 019042 *	4 235,00 019059 *
B 10 Bílá RAL 9010	2 202,00 018885 *	2 202,00 018892	4 235,00 018908 *
MZ 11 Mechově zelená RAL 6005	2 202,00 019004	2 202,00 019011	4 235,00 019028 *
ZS 12 Zinkově šedá RAL extra	2 202,00 019158 *	2 202,00 019165 *	4 235,00 019172 *
PZ 13 Patina zelená RAL extra			
PM 14 Patina měděná RAL extra			
Hliník 15 Natur	1 982,00 001481	1 982,00 001498	3 812,00 001504
Balení v ks 	1	1	1
Balení v ks 	60	60	60

* Výroba na objednávku



POZINKOVANÝ SVOD OCHRANNÝ S REVIZNÍM OTVOREM W-WOZR

Jmenovitá velikost	80	100	100
Délka v m	1,0	1,0	1,5
Cena v CZK/ks	S DPH	S DPH	S DPH
AN Antracit RAL 7016	1 2 168,00 030344 *	1 1 660,00 030351 *	3 2 866,00 030368 *
TM Testa di Moro RAL 8028	2 2 168,00 030641 *	1 1 660,00 030658 *	3 2 866,00 030665 *
SS Světle šedá RAL 7005	3 2 168,00 030597 *	1 1 660,00 030603 *	3 2 866,00 030610 *
ZH Zeleno hnědá RAL 7013	4 2 168,00 030696 *	1 1 660,00 030702 *	3 2 866,00 030719 *
BH Bílo hliníková RAL 9006	5 2 168,00 030795 *	1 1 660,00 030801 *	3 2 866,00 030818 *
BHT Bílo hliníková tmavá RAL 9007	6 2 168,00 102065 *	1 1 660,00 102072 *	3 2 866,00 102096 *
MH Měděno hnědá RAL 8004	7 2 168,00 030443 *	1 1 660,00 030450 *	3 2 866,00 030467 *
IC Intenzivní černá RAL 9005	8 2 168,00 030849 *	1 1 660,00 030856 *	3 2 866,00 030863 *
OC Ocelově červená RAL 3009	9 2 168,00 030542 *	1 1 660,00 030559 *	3 2 866,00 030566 *
B Bílá RAL 9010	10 2 168,00 030399 *	1 1 660,00 030405 *	3 2 866,00 030412 *
MZ Mechově zelená RAL 6005	11 2 168,00 030498 *	1 1 660,00 030504 *	3 2 866,00 030511 *
ZS Zinkově šedá RAL extra	12 2 168,00 030740 *	1 1 660,00 030757 *	3 2 866,00 030764 *
PZ Patina zelená RAL extra	13		
PM Patina měděná RAL extra	14		
Pozink Natur	2 033,00 009708	1 525,00 009715	3 015,00 009722
Balení v ks 	1	1	1
Balení v ks 	70	60	60

* Výroba na objednávku



POZINKOVANÝ SVOD OCHRANNÝ S REVIZNÍM OTVOREM W-WOZR





Jmenovitá velikost	120	120
Délka v m	1,0	1,5
Cena v CZK/ks	S DPH	S DPH
AN 1 Antracit RAL 7016	3 896,00	5 590,00
	030375 *	030382 *
TM 2 Testa di Moro RAL 8028	3 896,00	5 590,00
	030672 *	030689 *
SS 3 Světle šedá RAL 7005	3 896,00	5 590,00
	030627 *	030634 *
ZH 4 Zeleno hnědá RAL 7013	3 896,00	5 590,00
	030726 *	030733 *
BH 5 Bílo hliníková RAL 9006	3 896,00	5 590,00
	030825 *	030832 *
BHT 6 Bílo hliníková tmavá RAL 9007	3 896,00	5 590,00
	102102 *	102089 *
MH 7 Měděno hnědá RAL 8004	3 896,00	5 590,00
	030474 *	030481 *
IC 8 Intenzivní černá RAL 9005	3 896,00	5 590,00
	030870 *	030887 *
OC 9 Ocelově červená RAL 3009	3 896,00	5 590,00
	030573 *	030580 *
B 10 Bílá RAL 9010	3 896,00	5 590,00
	030429 *	030436 *
MZ 11 Mechově zelená RAL 6005	3 896,00	5 590,00
	030528 *	030535 *
ZS 12 Zinkově šedá RAL extra	3 896,00	5 590,00
	030771 *	030788 *
PZ 13 Patina zelená RAL extra		
PM 14 Patina měděná RAL extra		
Pozink Natur	3 557,00	4 845,00
	009739	009746
Balení v ks 	1	1
Balení v ks 	40	40

* Výroba na objednávku

POZINKOVANÁ OBJÍMKA S GUMOU M10

P-POB-OZR



Jmenovitá velikost	EAN číslo výrobku	Balení v ks		Cena s DPH [CZK/ks]
				
80	002525	25	1 250	53,00
100	002532	25	1 250	68,00
120	002549	20	1 000	76,00

